

# AIRGROUP

A u s t r a l i a

ABN 68 547 176 720

**COOL BREEZE**

## TECHNICAL MANUAL

### BOOK 4

2008 Edition

AIR GROUP AUSTRALIA MANUFACTURED UNITS ONLY

SERVICE GROUP AUSTRALIA  
28 - 30 DIVISION STREET  
WELSHPOOL WA 6106  
[www.airgroup.com.au](http://www.airgroup.com.au)



# CONTENTS

Page

Introduction and Abbreviations	4
Safety and Installation Notes	5

## **PASSIVE HEATING SERIES**

Wall Controllers	6 - 7
Wiring & Schematic Diagrams	8
Fault Finding Notes	9
General Operating Information	10
Additional Information	11-15

## **SOLECTAIR PLUS**

Wall Controller Manual	16-17
Wall Controller Auto	18-19
System Configuration	20
Set Point Adjustment	21
Fault Finding	22

## **SOLECTAIR UNO**

Wall Controller	23
System Operation	24
Set Point Adjustment	25
Fault Finding	26

## **ZONE CONTROL**

System Function	27
-----------------	----

# INTRODUCTION

This document is designed as a guide only, and does not cover all possible faults that may occur. It is intended for use by technicians and trades people with fault finding skills and relevant qualifications. Its aim is to help identify failed components and assist in diagnosis of system faults. The guide has been set out in logical order, from the basic to the more complex faults. All faults should be approached in this order and all instructions followed to avoid incorrect fault identification and/or part replacement. It should be noted that all information provided in this guide is based on current designs. Variations to these designs will be encountered on earlier models, since modifications have occurred to the product.

## ABBREVIATIONS

<b>V</b>	Volt
<b>W</b>	Watt
<b>DC</b>	Direct Current
<b>AC</b>	Alternating Current
<b>R/Control</b>	Remote Control
<b>mm</b>	Millimetres
<b>KDU</b>	Keypad Display Unit
<b>R/U</b>	Roof Unit
<b>cct</b>	Circuit
<b>LED</b>	Light Emitting Diode
<b>MWL</b>	Magnetic Water Level System

# SAFETY NOTES

## Electrical & Rotary Machinery

- All electrical equipment should be isolated before work is performed. If 'live testing' is required all necessary safety precautions should be followed.

## Working at Heights

- When work is to be performed at heights all necessary safety precautions should be followed.

# INSTALLATION NOTES

## Motor & Fan

- A fan clipping two opposite points of the cowling indicates the dropper is 'out of square'. Diagonal dimensions of dropper must be equal, +/-5mm.
- Centralise the fan in the cowling by tightening the nearest 8mm motor mounting nut to the point of contact. This will only achieve several millimetres of movement due to fan and cowling tolerances.
- When replacing a Roof Unit circuit board or fan motor a 'minimum speed set-up' (see page 10 for details) should be performed to avoid damaging motors by operating below specified minimum RPM values.
- Fan blade pitch should not be altered from factory setting as significant changes in motor loading, airflow and noise characteristics will result.

## Electrical

- All units should be powered from a dedicated circuit protected by a 10A or 15A re-wireable fuse or circuit breaker, (Ref: AS3000, 2.4.2). A GPO or socket outlet is not required and therefore RCD protection is not required. Flexible wiring can be joined to fixed wiring in a junction box, (Ref: AS3000, 3.7.2.7). Supplying a unit from an existing RCD protected power circuit may result in nuisance tripping of that device due to the sum of leakage current from all appliances on that circuit.
- Damage to equipment can occur if power is not isolated when connecting or disconnecting keypads, or appliances from Roof Units or MCU's.

# PASSIVE HEATING WALL CONTROLLER

(Attached to an evaporative air conditioner)

**Wall Control :** Solectair Controller (SP3072)

**Roof Unit:** Passive Heat MCU (SP3076)

**Motor Control Board:** Neatrol Roof Unit (SP3005)

**Control Cable:** 5-Pin Pre-terminated (SP5232)

**Fan Motor:** 600 W

**Fan Speed:**

- Variable Pot located inside filter box.
- Or slide switch on wall controller.

## Modes of Operation:

ON / OFF - Set to transfer heat when operating conditions are met.

TEMP ADJUST - Inside set temperature from 21<sup>0</sup> to 29<sup>0</sup> C

**MANUAL OVERRIDE** - Press ▼ ▲ buttons simultaneously, the fan will turn on and remain on independent of thermostat condition.

**Brands:**

- Solectair
- Eclipse

SOLECTAIR FRONT PANEL

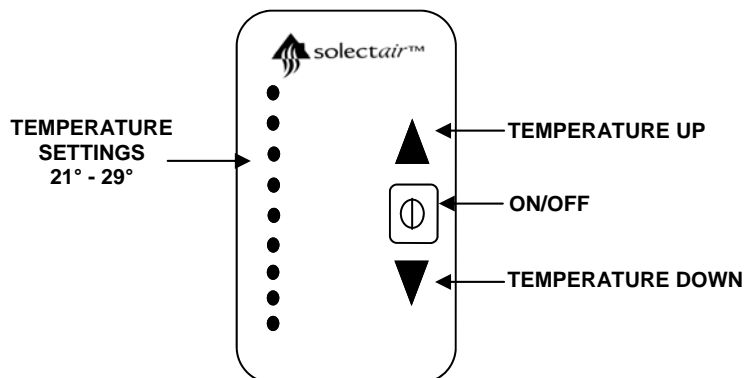

SOLECTAIR REAR PANEL

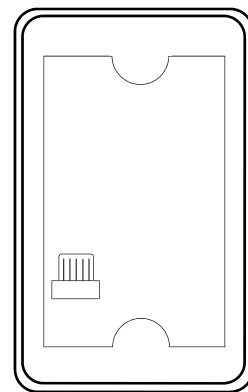

# PASSIVE HEATING LCD CONTROLLER

(Attached to an evaporative air conditioner)

- Wall Control :** Solectair LCD Controller (SP3070)
- Roof Unit:** Passive Heat MCU (SP3076)
- Motor Control Board:** Neatrol Roof Unit (SP3005)
- Control Cable:** 5-Pin Pre-terminated (SP5232)
- Fan Motor:** 600 W
- Fan Speed:**
- Variable Pot located inside filter box.
  - Or Slide Switch on wall controller.

## Modes of Operation:

ON / OFF - Set to transfer heat when operating conditions are met.

TEMP ADJUST - Inside set temperature from 21<sup>0</sup> to 29<sup>0</sup> C

**MANUAL OVERRIDE** - Press ▼ ▲ buttons simultaneously, the fan will turn on and remain on independent of thermostat condition.

- Brands:**
- Airstream
  - Solar Heating

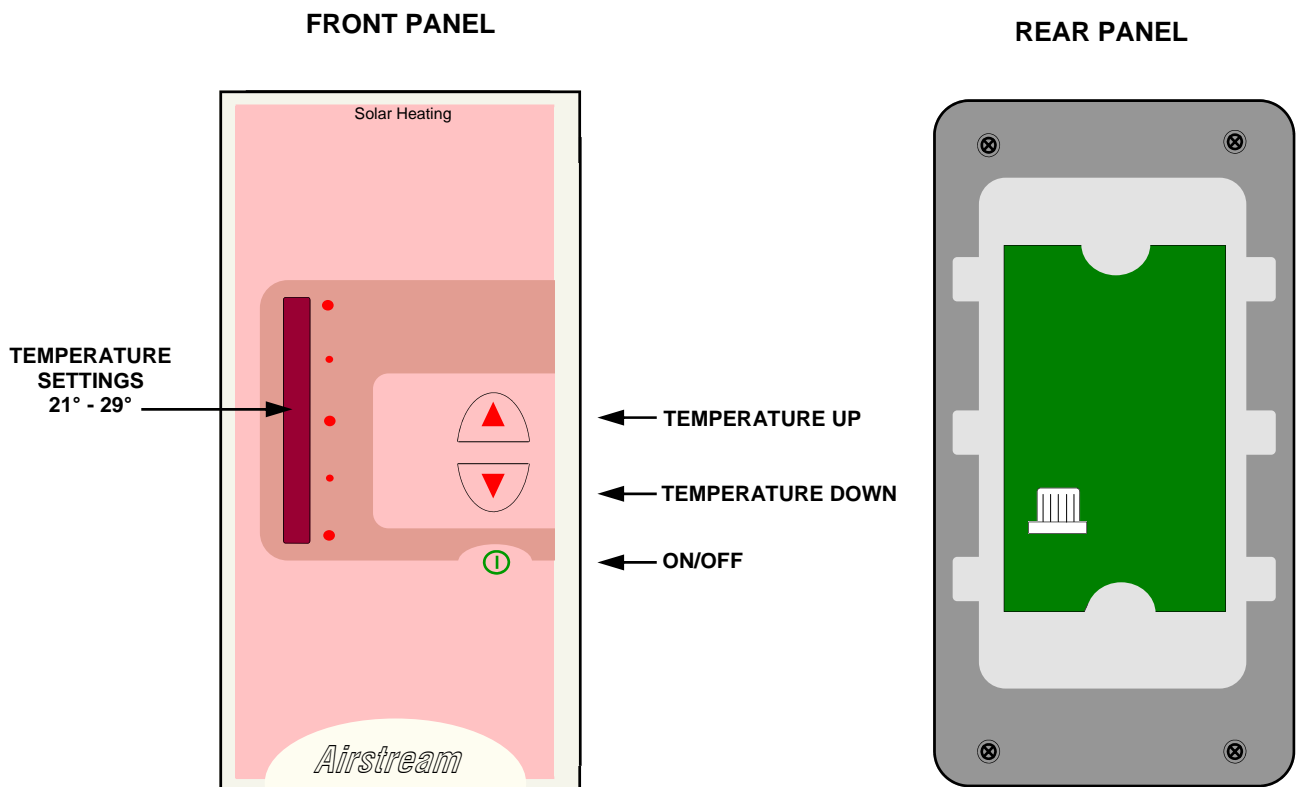

# PASSIVE HEAT MCU AND NEATROL SCHEMATIC DIAGRAMS

## PASSIVE HEAT MCU SCHEMATIC

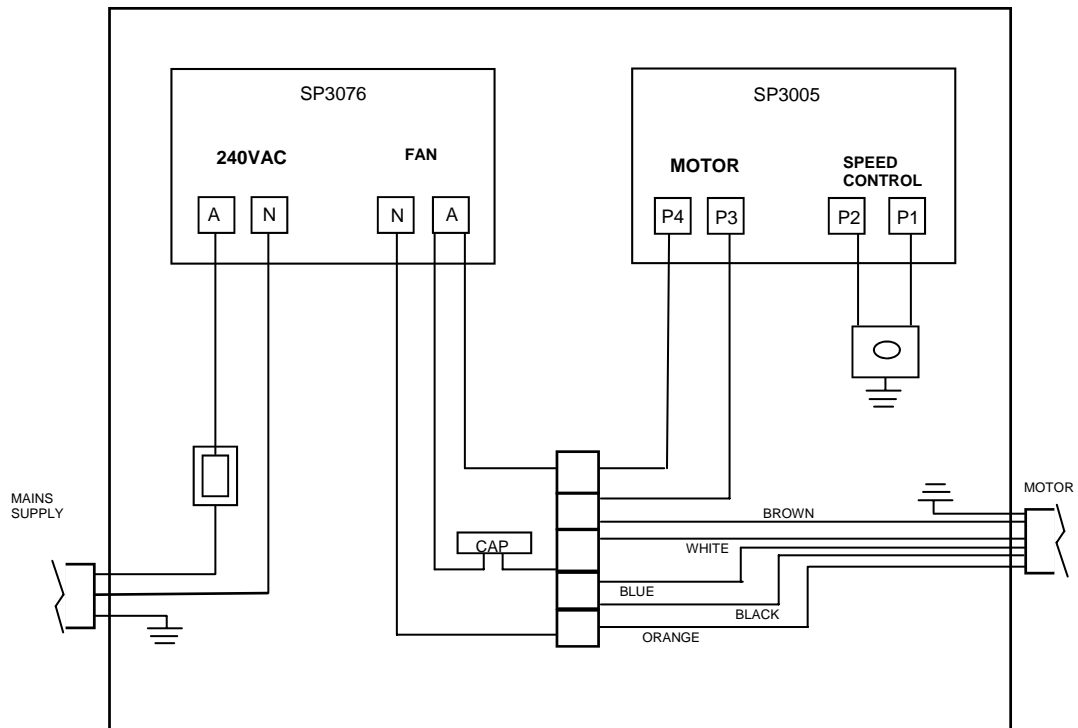

## NEATROL PCB - SPEED CONTROL WIRING DIAGRAM

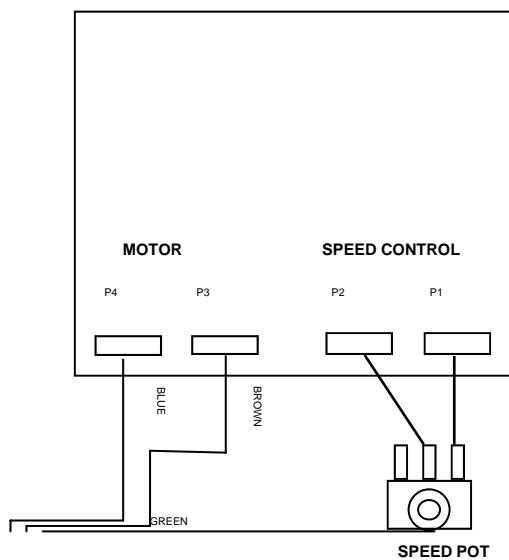

SET MOTOR SPEED AS PER TABLE			
MOTOR	SIZE	FAN COLOUR	RPM (MIN)
TECO	600W	GREY/GREEN HUB	800



# PASSIVE HEATING FAULT FINDING

ELECTRICAL FAULTS			
FAULT	Ref	CAUSE	ACTION
<b>1. NO LIGHTS ON KEY-PAD</b>	1.1	240 V mains supply isolated.	Check mains fuse or circuit breaker. Check Passive Heat MCU board and MCU fuse
	1.2	No power to keypad.	Confirm connectivity of 5 pin keypad cable.
<b>2. FAN NOT OPERATING</b>	2.1	Air in roof space not hot enough.	Press ▲▼ buttons simultaneously to manually run fan.
	2.2	Capacitor failure motor will buzz.	Replace capacitor.
	2.3	Motor not powered.	Check 6 pin plug & Neatrol board.
	2.4	Motor seized.	Replace motor.
	2.5	Motor jammed in cowling.	Centralize fan in cowling.
	2.6	Passive Heat MCU faulty.	Replace MCU.
FAN FAULTS			
FAULT	Ref	CAUSE	ACTION
<b>3. NO VARIATION OF FAN SPEED</b>	3.1	Neatrol Roof Unit failure.	Adjust speed pot in filter box. Replace Neatrol board.
<b>4. FAN CUTS OUT</b>	4.1	Passive heat MCU faulty or keypad faulty.	Replace MCU or keypad.
	4.2	Motor failure or shutdown due to internal motor thermal protection.	Check run current, if running at more than 120% of value on motor replace the motor.

# PASSIVE HEATING SYSTEM OPERATION

(Attached to an evaporative air conditioner)

## WALL CONTROLLER

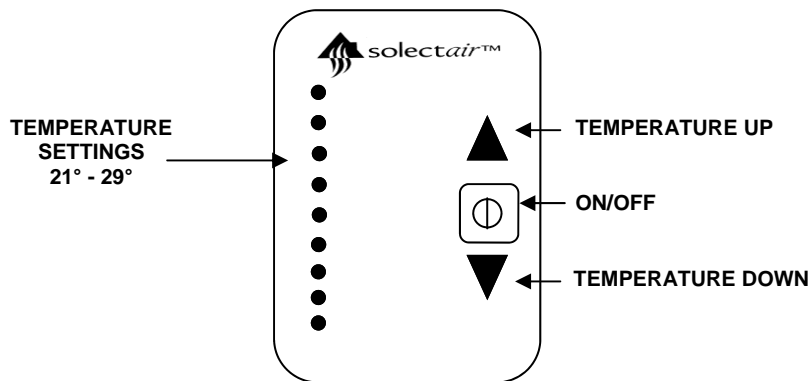

### On/Off

- If one of the temperature indicators is illuminated the system is switched on and is ready to transfer heat when the operating conditions are met.
- No lights indicate that the system is off.



### Temp Adjust

- The SET temperature is raised or lowered.

The illuminated indicators on the wall controller correspond to temperature settings of approximately 21 to 29 degrees.

### Fan Speed

- Adjust the fan speed to suit your requirement.
- There are two types of fan speed adjustment on Solectair systems. Select the one that applies to your system.
  1. A slide switch located on the wall controller
  - OR 2. A rotary knob located just inside the filter box.

**Manual Override - Press the ▲ ▼ and temperature buttons simultaneously.  
The fan will turn and remain on.**

## HOW TO USE YOUR SOLECTAIR SYSTEM

1. Press the on/off button. An indicator will illuminate. The system is now ready.
2. Adjust the required indoor temperature using the ▲ ▼ buttons.
3. Setting the temperature to the highest setting (29°) will have the maximum heating effect. This is recommended when your home is unoccupied as indoor temperatures could reach the maximum setting of 29°. The maximum heat available will be absorbed into the interior fittings and home structure. This stored heat will continue to be slowly released back into the air after the system is switched off.
4. If your home is occupied during the day, setting the temperature level to maximum may cause indoor temperatures to rise above the comfort level. We recommend setting the temperature control to 22° to 24°. Remember the lowest setting corresponds to about 21° and rises in 1° increments.
5. Adjust the fan speed to a comfortable level. The highest setting will give the most amount of heat transfer. During times when the amount of heat available in the roof space is at a lower level, the air may appear to be cool even though it still contains useful heat. Turning down the fan will reduce the 'draft' effect. A comfortable 'all year round' setting may possibly be around 40% of the fan's capacity. This adjustment is done during installation and commissioning.
6. At the end of summer, switch the system on and leave it on, to achieve the best effect. Whenever useful heat is available in the roof space, it will be transferred into the living area.

# PASSIVE HEATING SYSTEM OPERATION

## MAXIMISING PERFORMANCE

1. Adjust the temperature control to the maximum setting.
2. Keep external doors and windows closed. Air will be recirculated back into the roof space via the return air vent.
3. To reduce heat loss at night, as stored heat is released, close curtains and shut internal doors to unused rooms.
4. The best results will be obtained from darker coloured roofs, but good heating is available from all metal roofs and mid to darker coloured tile roofs. Avoid roofs with white tiles. Do not fit Solectair to roofs with insulation on the underside of the roof cladding.
5. Ceiling insulation is essential.

## CLEANING THE FILTER

The filter is located behind the ceiling grille and should be cleaned at regular intervals depending on the outside environment. We recommend at least once a year.

A dirty filter will be evidenced by a drop in air flow and performance.

1. Undo the two screws holding the filter access door in place and remove the door.
2. Unclip the filter from the bottom two retainers and carefully withdraw it from the duct and the filter housing.
3. Vacuum clean the inside of the filter thoroughly. It will be necessary to turn it inside out. Remember to pull it back again. What was the inside prior to cleaning should always remain as the inside.
4. Replace and clip the filter back into position. Tuck the poly sleeve inside the filter.
5. Screw the access door back into place.

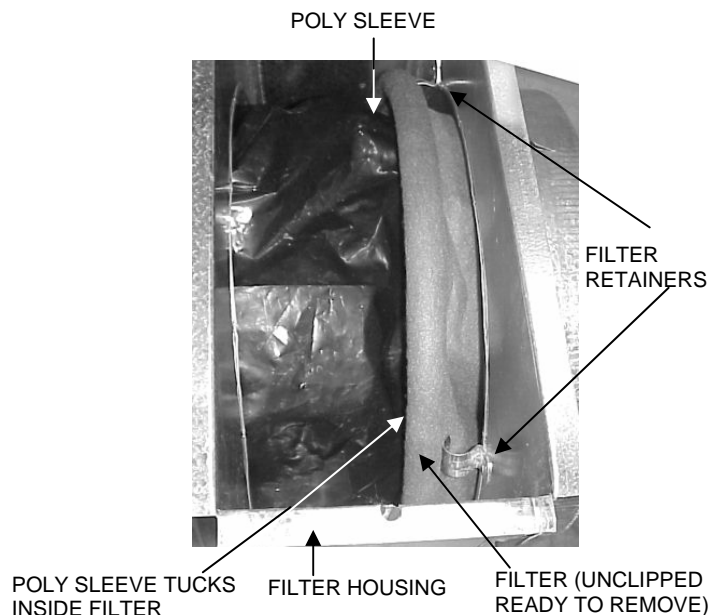

## POWER CONSUMPTION

Power consumption will vary from 400w at low speed to 600w at high speed. Assuming a mid temperature setting, the fan will most likely cycle on and off during the day. Over a 7 hour period (9am to 4pm), cycling the system on low speed will consume around 1.4kw of power, and on high speed on the maximum setting (heat saturation mode), 5.6kw of power. Compared to conventional forms of heating, the overall running costs are minimal.

# PASSIVE HEATING SYSTEM OPERATION

## FILTER CLEANING 2007

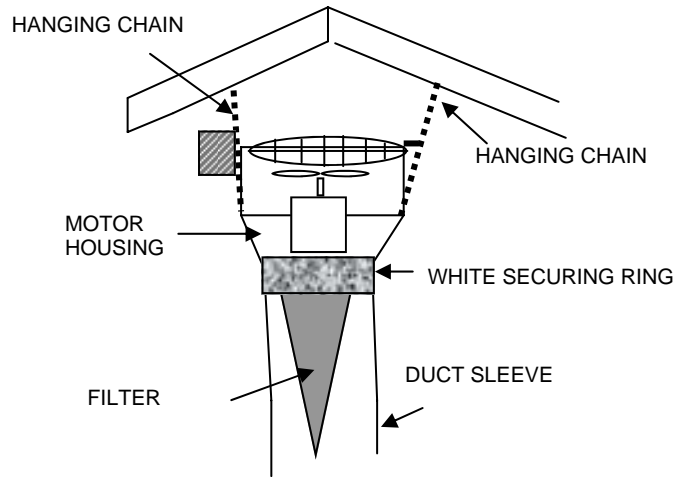

### CLEANING THE FILTER

The filter is located in the duct coming directly off of the motor housing. A dirty filter will be evidenced by a drop in air flow and performance.

# ADDITIONAL PASSIVE HEATING INFORMATION

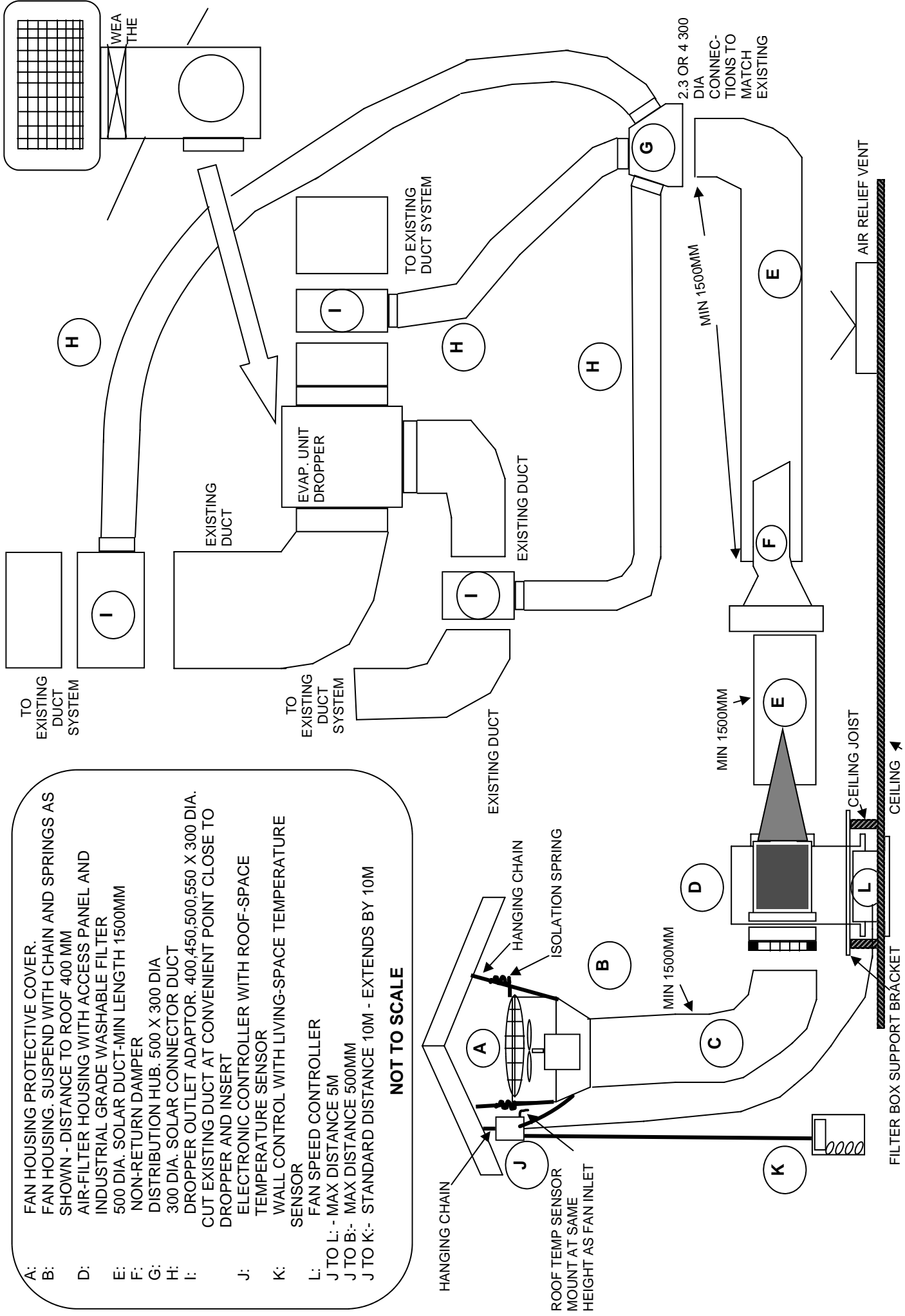

- A: FAN HOUSING PROTECTIVE COVER.
- B: FAN HOUSING. SUSPEND WITH CHAIN AND SPRINGS AS SHOWN - DISTANCE TO ROOF 400 MM
- D: AIR-FILTER HOUSING WITH ACCESS PANEL AND INDUSTRIAL GRADE WASHABLE FILTER
- E: 500 DIA. SOLAR DUCT-MIN LENGTH 1500MM
- F: NON-RETURN DAMPER
- G: DISTRIBUTION HUB. 500 X 300 DIA
- H: 300 DIA. SOLAR CONNECTOR DUCT
- I: DROPPER OUTLET ADAPTOR. 400,450,500,550 X 300 DIA. CUT EXISTING DUCT AT CONVENIENT POINT CLOSE TO DROPPER AND INSERT
- J: ELECTRONIC CONTROLLER WITH ROOF-SPACE TEMPERATURE SENSOR
- K: WALL CONTROL WITH LIVING-SPACE TEMPERATURE SENSOR
- L: FAN SPEED CONTROLLER
- J TO L: - MAX DISTANCE 5M
- J TO B: - MAX DISTANCE 500MM
- J TO K: - STANDARD DISTANCE 10M - EXTENDS BY 10M

**NOT TO SCALE**

**FIGURE A** SOLECTAIR SYSTEM INSTALLED WITH EVAPORATIVE AIR CONDITIONER AND DISTRIBUTION HUB

# ADDITIONAL PASSIVE HEATING INFORMATION

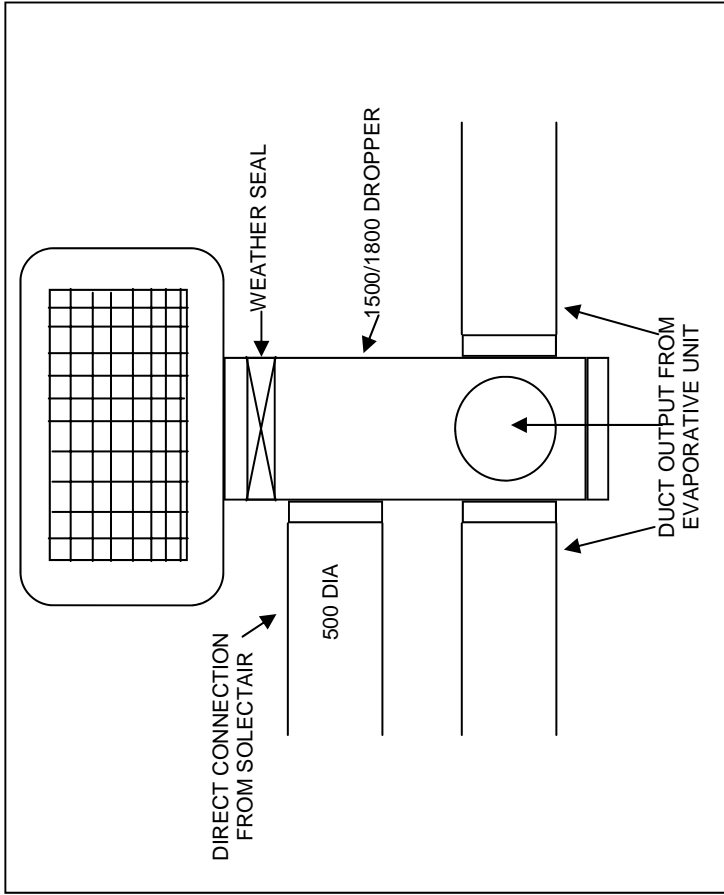

- A: FAN HOUSING PROTECTIVE COVER.
  - B: FAN HOUSING. SUSPEND WITH CHAIN AND SPRINGS AS SHOWN - DISTANCE TO ROOF 400 MM
  - D: AIR-FILTER HOUSING WITH ACCESS PANEL AND INDUSTRIAL GRADE WASHABLE FILTER
  - E: 500 DIA. SOLAR DUCT-MIN LENGTH 1500MM
  - F: NON-RETURN DAMPER
  - G: DISTRIBUTION HUB. 500 X 300 DIA
  - J: ELECTRONIC CONTROLLER WITH ROOF-SPACE TEMPERATURE SENSOR
  - K: WALL CONTROL WITH LIVING-SPACE TEMPERATURE SENSOR
  - L: FAN SPEED CONTROLLER
  - J TO L: - MAX DISTANCE 5M
  - J TO B: - MAX DISTANCE 500MM
  - J TO K: - STANDARD DISTANCE 10M - EXTENDS BY 10M
- NOT TO SCALE**

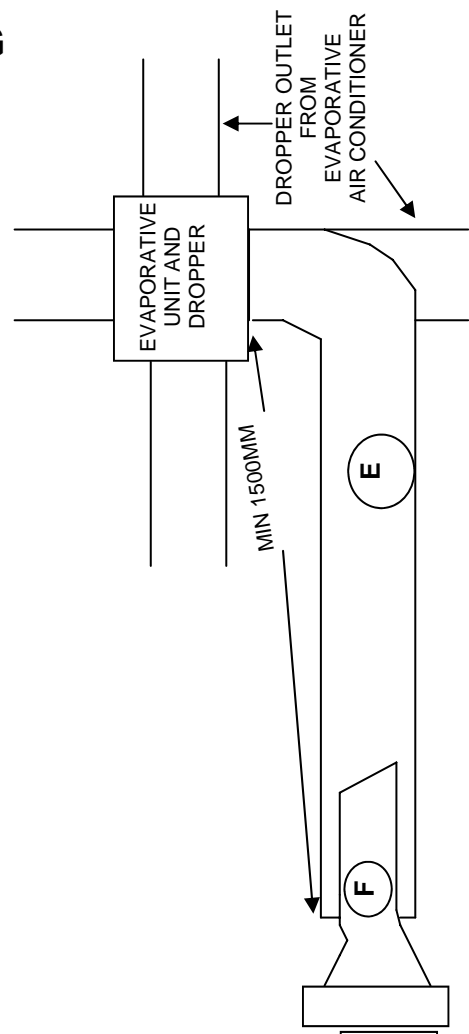
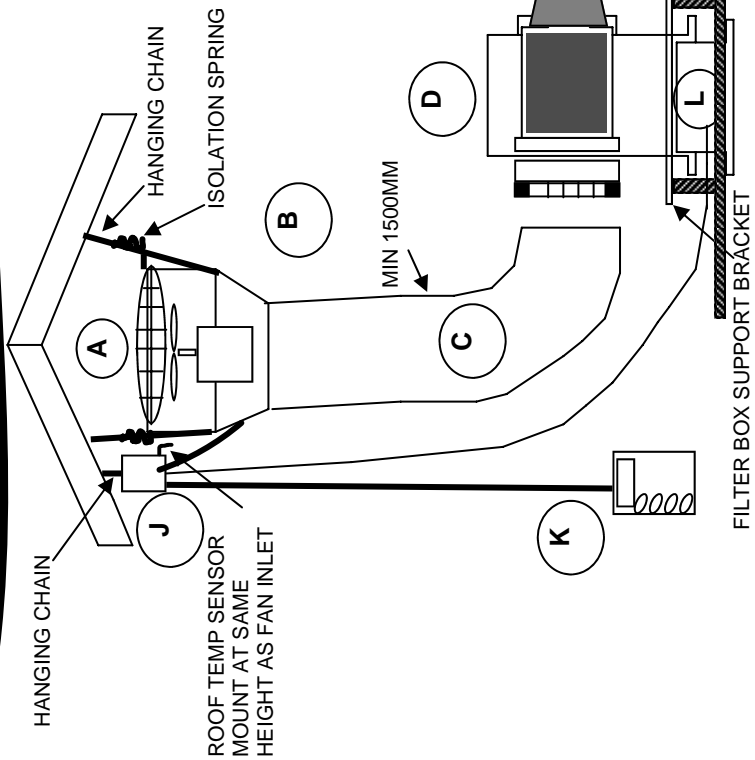
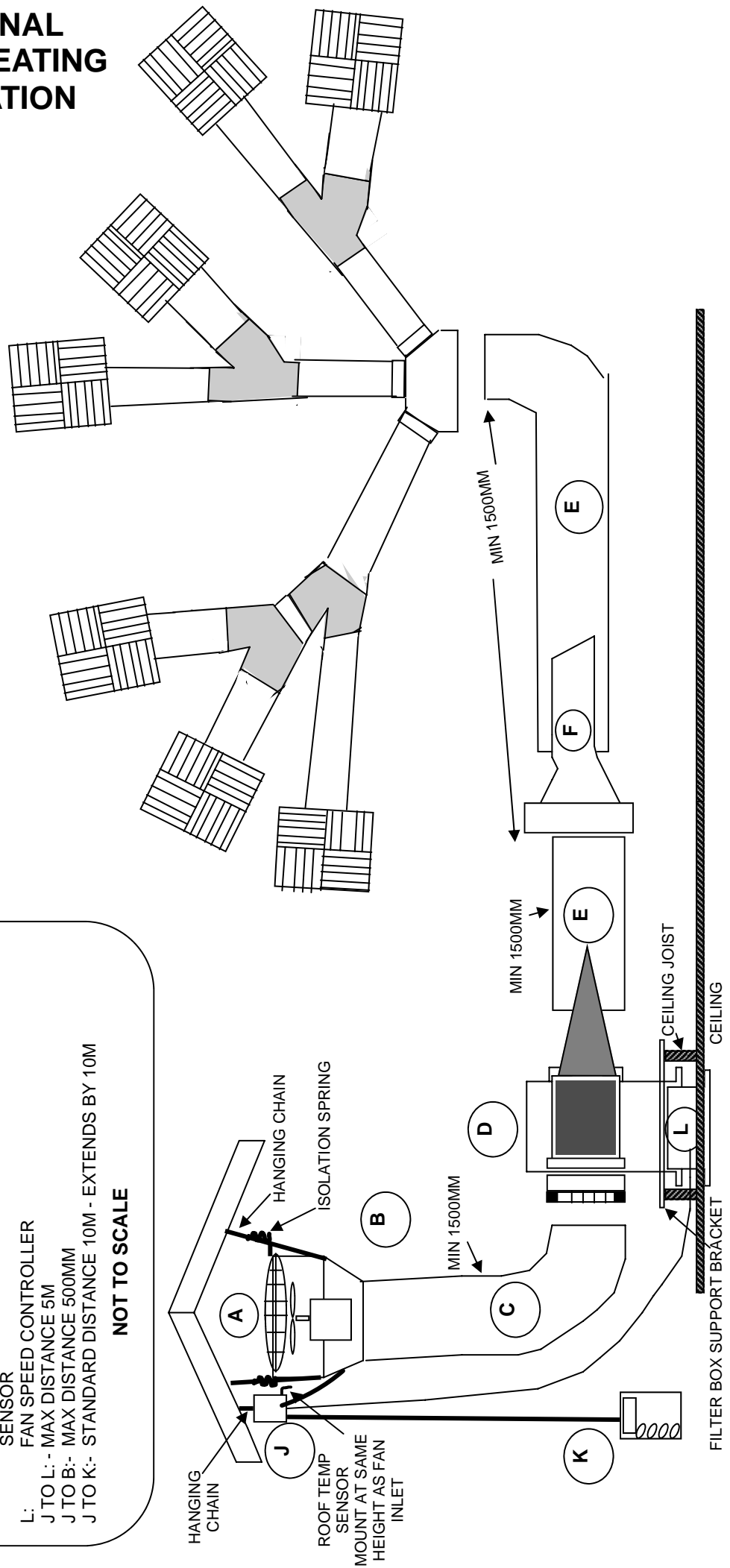

**FIGURE B** SOLECTAIR INSTALLED WITH EVAPORATIVE AIR CONDITIONER AND DIRECT 1500/1800 DROPPER CONNECTION FROM SOLECTAIR

# ADDITIONAL PASSIVE HEATING INFORMATION

- A: FAN HOUSING PROTECTIVE COVER.
- B: FAN HOUSING. SUSPEND WITH CHAIN AND SPRINGS AS SHOWN - DISTANCE TO ROOF 400 MM
- D: AIR-FILTER HOUSING WITH ACCESS PANEL AND INDUSTRIAL GRADE WASHABLE FILTER
- E: 500 DIA. SOLAR DUCT-MIN LENGTH 1500MM
- F: NON-RETURN DAMPER
- G: DISTRIBUTION HUB. 500 X 300 DIA
- J: ELECTRONIC CONTROLLER WITH ROOF-SPACE TEMPERATURE SENSOR
- K: WALL CONTROL WITH LIVING-SPACE TEMPERATURE SENSOR
- L: FAN SPEED CONTROLLER
- J TO L:- MAX DISTANCE 5M
- J TO B:- MAX DISTANCE 500MM
- J TO K:- STANDARD DISTANCE 10M - EXTENDS BY 10M

**NOT TO SCALE**



**FIGURE C** SOLECTAIR SYSTEM INSTALLED AS STAND-ALONE HEATING SYSTEM

# SOLECTAIR PLUS SYSTEM OPERATION

(Attached to a ducted gas heater)

**Wall Control :** Solectair Plus Controller 2 Button (SP3075)  
Solectair Plus Controller 4 Button (SP3078)

**Roof Unit:** Solectair Plus Main Control Board ZCRU (SP3703)

**Control Cable:** 8-Pin Pre-terminated (SP5222)

## Modes of Operation:

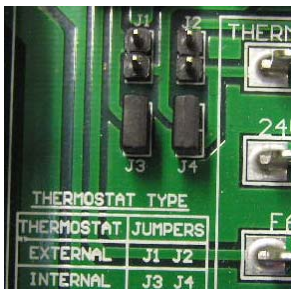
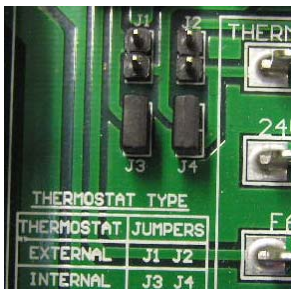
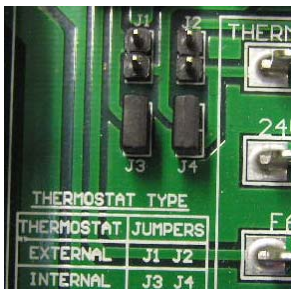
FOUR BUTTON SOLECTAIR PLUS KEYPAD OPERATION MANUAL CONTROL SYSTEM								
	<table border="1" style="width: 100%;"> <thead> <tr> <th style="text-align: center;">Jumper</th> <th style="text-align: center;">Jumper J3 &amp; J4 - ON</th> </tr> </thead> <tbody> <tr> <td style="text-align: center;">Located on rear of controller</td> <td style="text-align: center;">Located on Roof Unit</td> </tr> <tr> <td>J1 - OFF - "Night Cool &amp; Fresh Air"</td> <td rowspan="2" style="text-align: center;">  </td> </tr> <tr> <td>J2 - ON - "Solectair Thermostat"</td> </tr> </tbody> </table>	Jumper	Jumper J3 & J4 - ON	Located on rear of controller	Located on Roof Unit	J1 - OFF - "Night Cool & Fresh Air"		J2 - ON - "Solectair Thermostat"
Jumper	Jumper J3 & J4 - ON							
Located on rear of controller	Located on Roof Unit							
J1 - OFF - "Night Cool & Fresh Air"								
J2 - ON - "Solectair Thermostat"								
MODE	FUNCTION							
Standby	Ambient temperature displayed							
To activate and de-activate functions	Select the desired function and push the button. The indicator light next to the function selected will be illuminated. To de-activate the current function press the button and the indicator light will go off. Each function must be de-activated prior to activating a different function with the exception of Heat Boost.							
SOLAR	Operates the Solectair function of the system. Warm air will be introduced from the roof space when the following conditions apply: <ul style="list-style-type: none"> <li>A. The roof temperature is greater than 20°C.</li> <li>B. The roof temperature is at least 5°C greater than the room temperature.</li> <li>C. The room temperature is 1°C below the set point.</li> </ul>							
SOLAR + HEAT	The Solectair function of the system will operate as above, with the backup of the gas furnace if the following conditions apply: <ul style="list-style-type: none"> <li>A. The room temperature is less than the set-point by 1°C.</li> <li>B. There is less than 5°C difference between the room temperature and the roof temperature.</li> <li>C. The roof temperature is less than 20°C.</li> </ul>							
HEAT BOOST	When in "Solar or Solar + Heat" you can override the Solectair/Furnace Thermostat set point by selecting Heat Boost. The furnace will supply heat for up to 10 minutes After this timed period, the control will return to the previous setting.							
HEAT	This is the Gas Furnace mode. The Furnace will operate when the room temperature is below the set-point by 1°C.							



# SOLECTAIR PLUS SYSTEM OPERATION

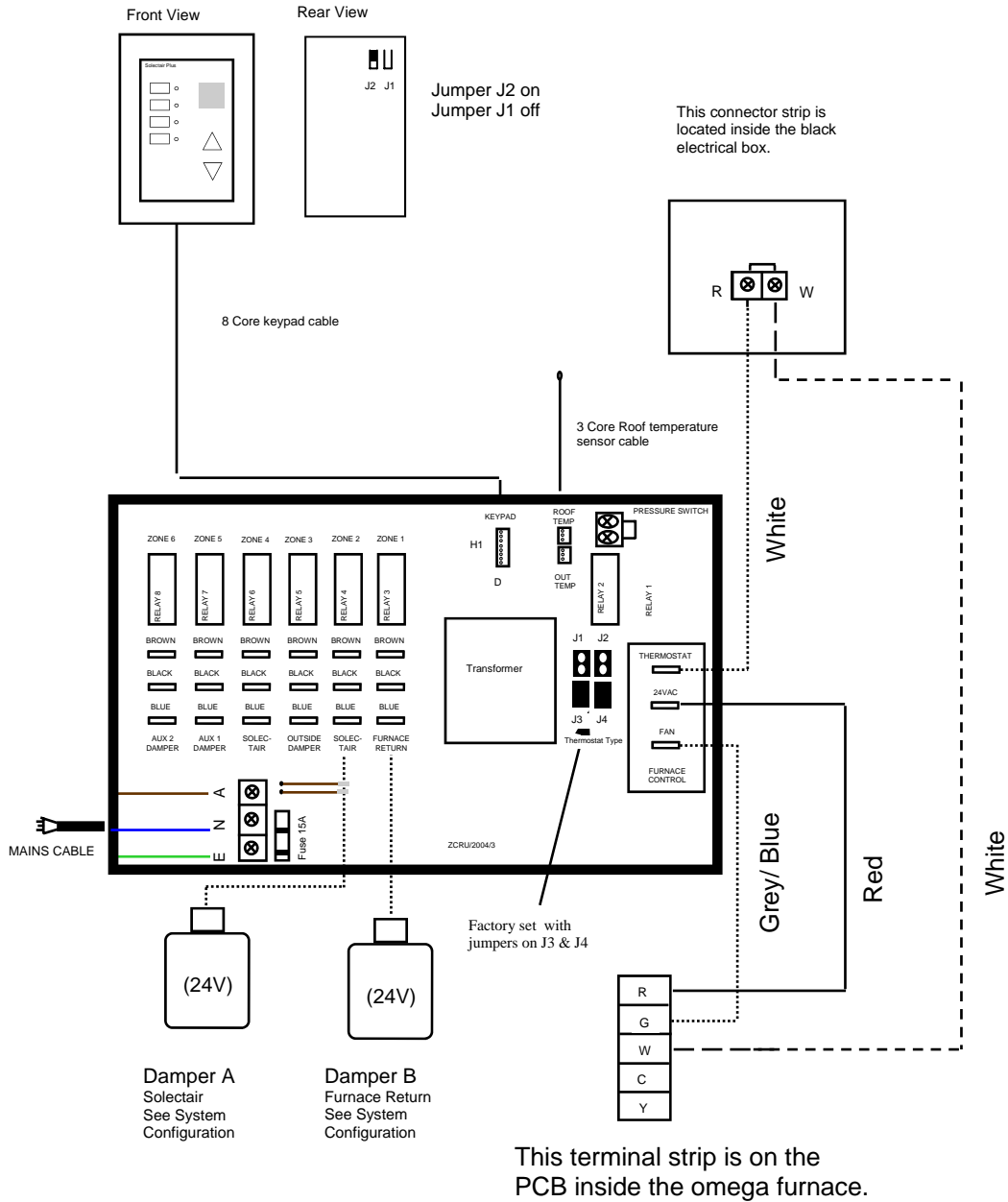

## THERMOSTAT 4 BUTTON SOLECTAIR PLUS KEYPAD MANUAL CONTROL SYSTEM

AS PER FACTORY SETTING



# SOLECTAIR PLUS SYSTEM OPERATION

(Attached to a ducted gas heater)

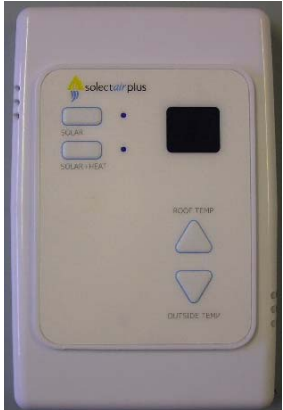
<b>AUTO CONTROL SYSTEM THERMOSTAT JUMPER SETTING TABLE</b>		
MAIN CONTROL CIRCUIT BOARD JUMPER SETTING FOR SYSTEMS FITTED WITH 2 BUTTON SOLECTAIR PLUS AND AUTO THERMOSTAT CONTROLLERS.		
THERMOSTAT	MAIN CONTROL CIRCUIT BOARD JUMPERS	SOLECTAIR PLUS CONTROLLER
<b>OMEGA AUTO</b> 	<b>J1 &amp; J2 on</b> 	<b>J2 Off J1 Off (see rear of keypad)</b> 

<b>TWO BUTTON SOLECTAIR PLUS KEYPAD OPERATION</b>	
MODE	FUNCTION
Standby	Ambient temperature displayed
To activate and de-activate functions	Select the desired function. The indicator light next to the function selected will be illuminated. To de-activate the current function press the button and the indicator light will go off. Each function must be de-activated prior to activating a different function.
SOLAR	Operates the Solectair function of the system. Warm air will be introduced from the roof space when the following conditions apply: <ul style="list-style-type: none"> <li>A. The roof temperature is greater than 20°C.</li> <li>B. The roof temperature is at least 5°C greater than the room temperature.</li> <li>C. The room temperature is 1°C below the set point.</li> </ul>
SOLAR + HEAT	The Solectair function of the system will operate as above, with the backup of the gas furnace if the following conditions apply: <ul style="list-style-type: none"> <li>A. The room temperature is less than the set-point by 1°C.</li> <li>B. There is less than 5°C difference between the room temperature and the roof temperature.</li> <li>C. The roof temperature is less than 20°C.</li> </ul>

**NOTE:**

The Solectair Plus thermostat is factory set to 25°C.

The Omega Auto thermostat is factory set to 20°C.

The Omega Auto thermostat must be set below the Solectair Plus thermostat as this has priority.

# SOLECTAIR PLUS SYSTEM OPERATION

## AUTO THERMOSTAT WITH 2 BUTTON SOLECTAIR PLUS KEYPAD

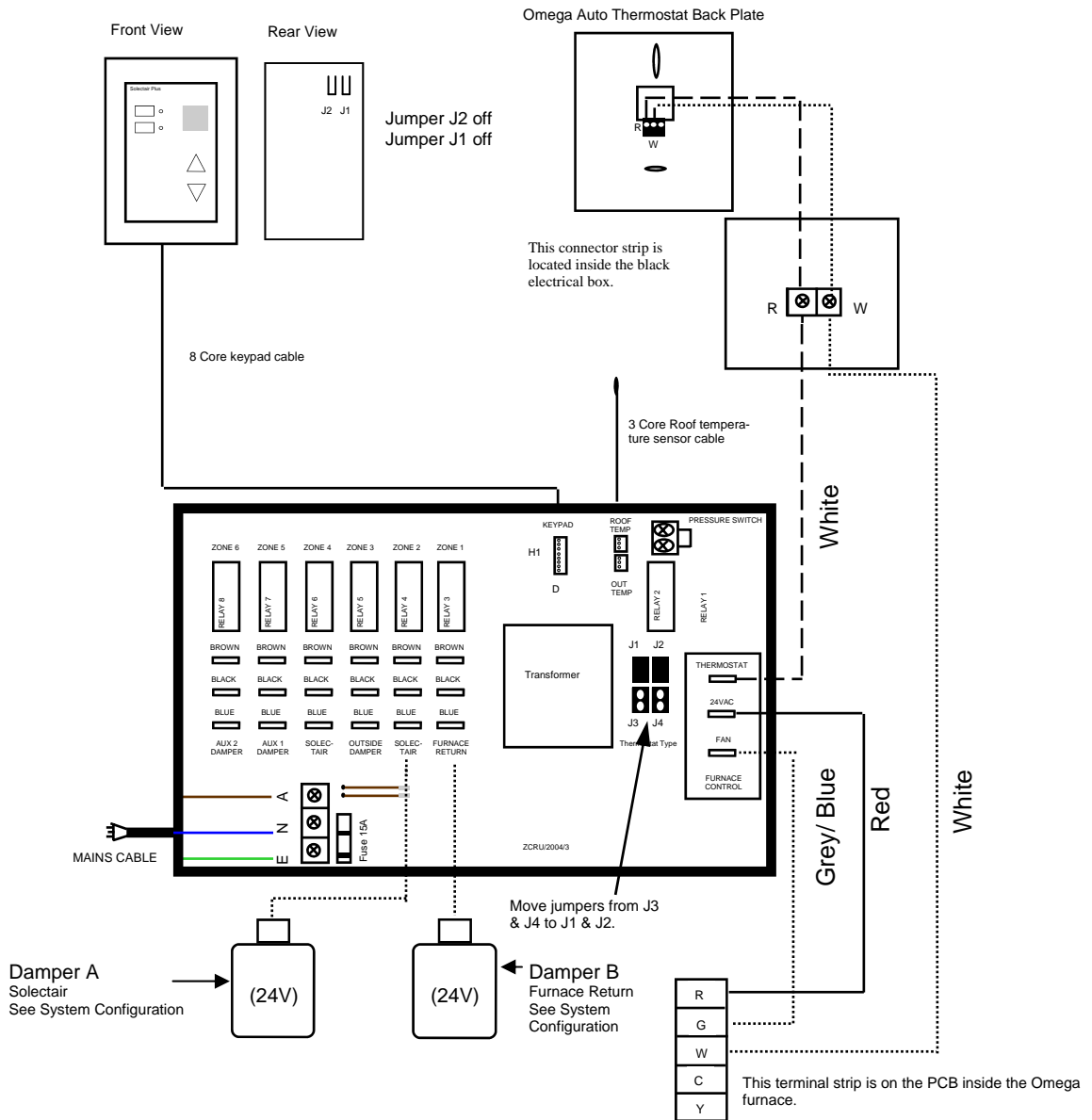

## SOLECTAIR PLUS TO OMEGA FURNACE WIRING DIAGRAM

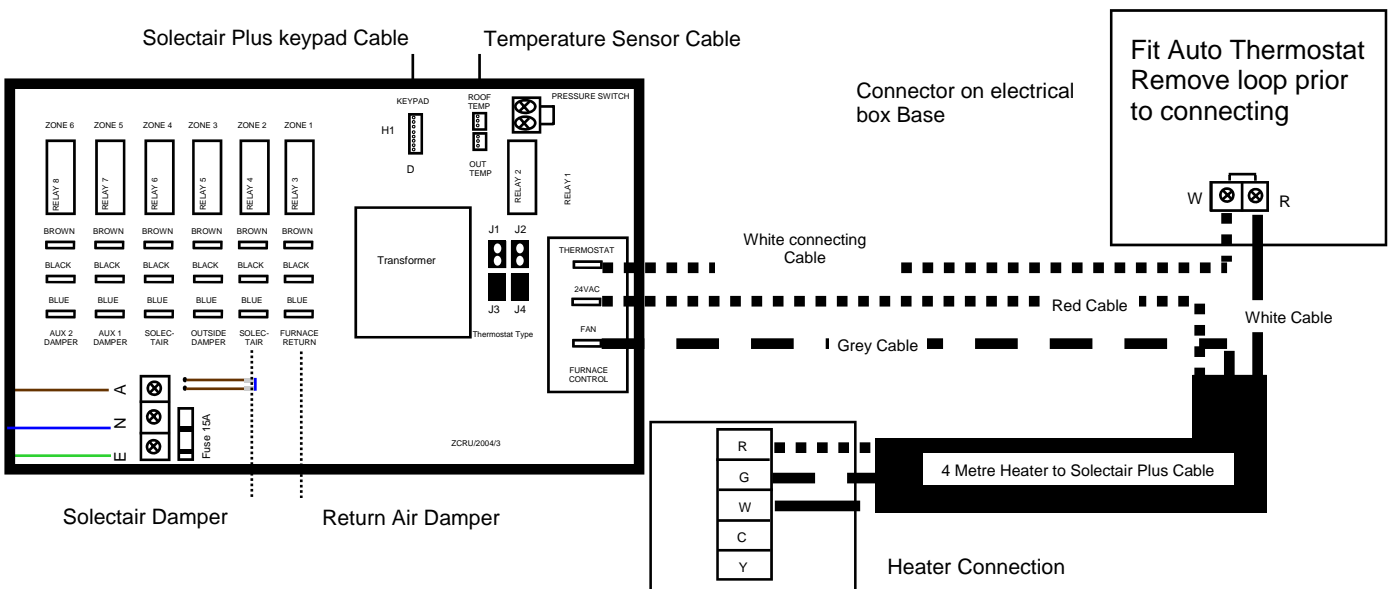

# SOLECTAIR PLUS SYSTEM OPERATION

## SYSTEM CONFIGURATION

The Solectair Plus with its thermostat, fan and damper control allows a ducted solar heat transfer system to be interfaced with a ducted gas heating system,

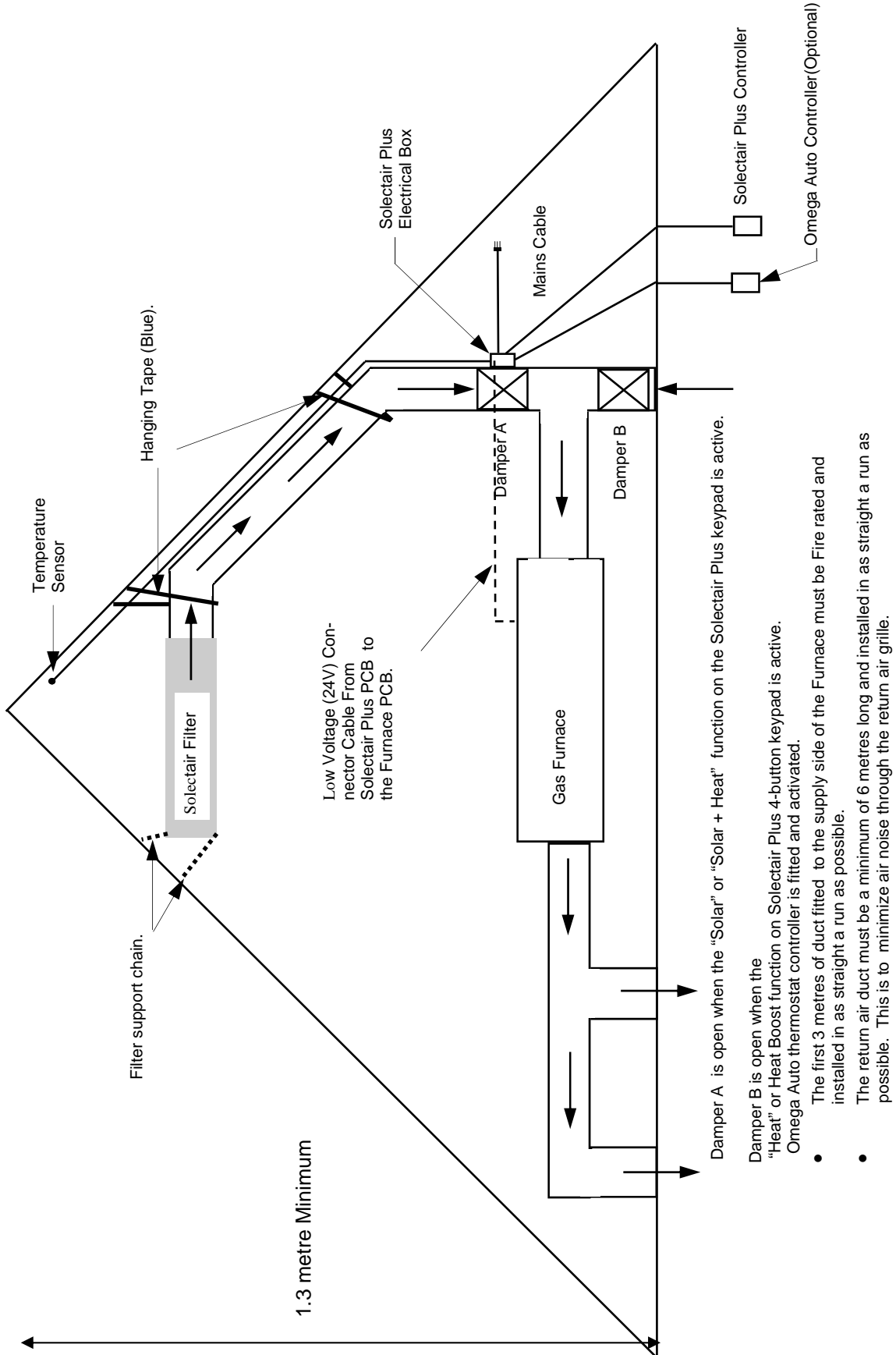



# SOLECTAIR PLUS SYSTEM OPERATION



## ADJUSTING THE SOLECTAIR PLUS SET POINT

The set point is the desired room temperature.  
The factory set point is 25°C and will default to this should the unit suffer a power loss.

## CHANGING THE SET POINT

ACTION	RESPONSE
Press Solar followed by the  button.	Display will flash 25°C which is the factory set port.
While the display is flashing use the  or  keys to change the set point.	Temperature will increase or decrease.
After setting the display will stop flashing.	Ambient temperature will be Displayed.
Press Solar.	De-activate Solar function.

## READING OF ROOF TEMPERATURE

Whilst in standby mode press the  key and the display will flash the roof temperature. If the  key is activate the display will flash "0".

## SOLECTAIR PLUS FAULT FINDING

Both Manual (4 Button) and Auto controllers.

Before undertaking any work on a Solectair Plus unit confirm all jumpers are correct. For gas faults see page 19 and 20

FAULT	Ref	CAUSE	ACTION
1. No warm air	1.1	Turn off power to MCU. Disconnect R W & G connection at gas furnace PCB. Using a bridge wire connect R & W. Gas furnace should operate . If unit fails	Insert LED indication (Inside of Omega unit)
	1.2	Bridge R & G. Fan should run	

Technician requires a test keypad and test thermostat

### ELECTRICAL FAULTS

FAULT	Ref	CAUSE	ACTION
1. No lights on keypad	1.1	2240v Mains supply isolated	Check mains supply & fuse. Red LED on ZCRU
2. No air out of registers	2.1	Insufficient warm air in roof space	Using test thermostat raise roof air temperature. Faulty temperature sensor cable
	2.2	Damper closed	Test for 24 vac at damper connections on ZCRU. If present replace damper motor. If not present replace ZCRU

# SOLECTAIR UNO SYSTEM OPERATION

## Stand Alone Product

**Wall Control :** Solectair Controller (SP3087)

**Roof Unit:** Solectair Uno MCU ZCRUU (SP3092)

**Motor Control :** Damper Motor (SP3091)

### WALL CONTROLLER

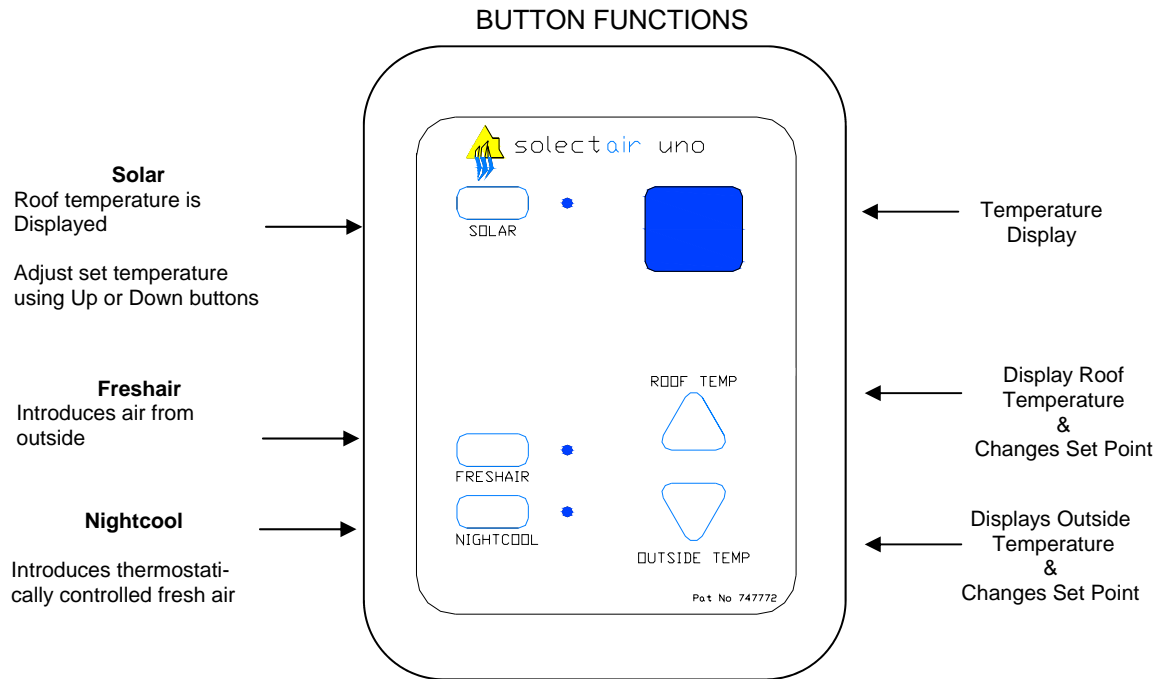

<b>SOLECTAIR UNO KEYPAD OPERATION</b>	
BUTTON	FUNCTION
To activate and de-activate functions	Select the desired function and push the button. The indicator light next to the function selected will be illuminated. To de-activate the current function press the button and the indicator light will go off. Each function must be de-activated prior to activating a different function with the exception of Heat Boost.
SOLAR	Operates the Solectair function of the system. Warm air will be introduced from the roof space when the following conditions apply: <ul style="list-style-type: none"> <li>A. The roof temperature is greater than 20°C.</li> <li>B. The roof temperature is at least 5°C greater than the room temperature.</li> <li>C. The room temperature is 1°C below the set point.</li> </ul>
FRESHAIR	The Freshair function introduces air from outside of the house regardless of room temperature
NIGHTCOOL	Introduces thermostatically controlled fresh air into the house from outside. Nightcool will work under the following condition: <ul style="list-style-type: none"> <li>1. The room temperature is greater than the outside temperature by 2°C and more than 1°C above the Nightcool set point.</li> </ul>
General Information	<ul style="list-style-type: none"> <li>1. Function buttons are activated by pushing once for On and push again for Off</li> <li>2. Pushing another button also switches the previous mode Off</li> <li>3. The indicator LED next to the button flashes when the function is active.</li> <li>4. To check roof temperature press Up button.</li> <li>5. To check outside temperature press Down button.</li> </ul>

# SOLECTAIR UNO SYSTEM OPERATION

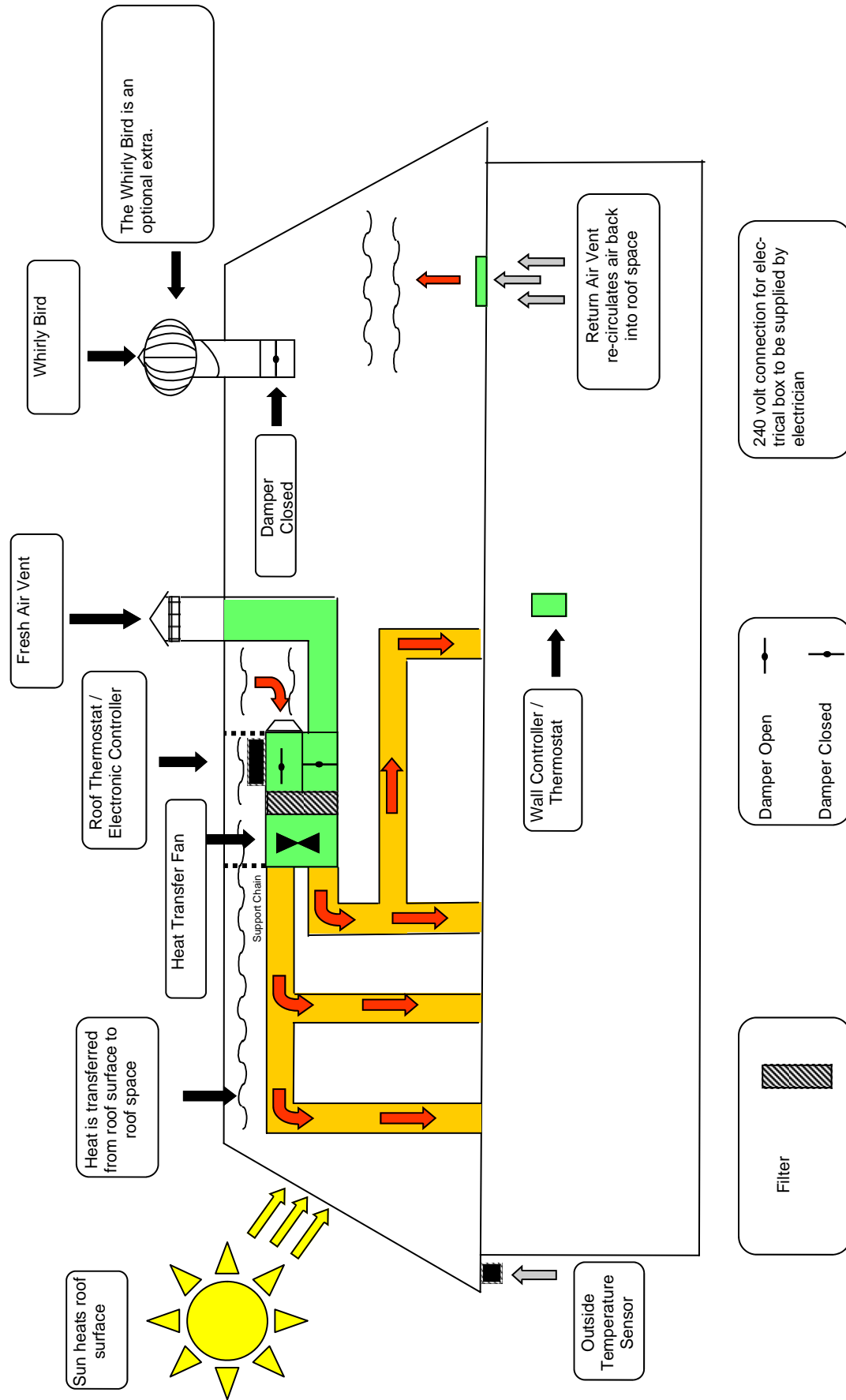



# SOLECTAIR UNO SYSTEM OPERATION

<b>ADJUSTING THE SOLECTAIR SET POINT</b>	
<p>The set point is the optimal room temperature required by the user. The factory set point for the Solectair function is 25°C.</p>	
<b>CHANGING THE SET POINT</b>	
ACTION	RESPONSE
Press Solar followed by the Up button	Display will flash
While the display is flashing use the Up or Down keys to change the set point.	Temperature will increase or decrease
After setting the display will stop flashing	Ambient temperature will be displayed
<b>READING OF ROOF &amp; OUTSIDE TEMPERATURE</b>	
<p>With the Solectair function Off.</p> <p>Press the Up key and the display will flash the Roof temperature.</p> <p>Press the Down key and the display will flash the Outside temperature.</p>	

<b>ADJUSTING THE NIGHTCOOL SET POINT</b>	
<p>The set point is the optimal room temperature required by the user. The factory set point for the Nightcool is 20°C.</p>	
<b>CHANGING THE SET POINT</b>	
ACTION	RESPONSE
Press Nightcool followed by the Up button	Display will flash
While the display is flashing use the Up or Down keys to change the set point.	Temperature will increase or decrease
After setting the display will stop flashing	Ambient temperature will be displayed
<b>READING OF ROOF &amp; OUTSIDE TEMPERATURE</b>	
<p>With the Nightcool functions Off.</p> <p>Press the Up key and the display will flash the Roof temperature.</p> <p>Press the Down key and the display will flash the Outside temperature.</p>	

# SOLECTAIR UNO FAULT FINDING

## Stand Alone Product

FAULT	Ref	CAUSE	ACTION
1. No lights on keypad	1.1	240v Mains supply isolated	Check mains supply and fuse. Red LED on MCU ZCRUU
2. Fan not Operating when in solar mode	2.1	Insufficient warm air in roof space	Using test thermostat raise roof air temperature
	2.2	Select "Freshair" if fan runs. This will confirm motor is good	

### JUMPER SETTINGS

Jumpers located on rear of controller  
 J1 - Nightcool and Fresh - ON  
 J2 - Solectair Thermostat - ON

Jumpers located on MCU ZCRUU  
 J3 - ON  
 J4 - ON



# ZONE CONTROL

- Wall Control :** Zone Controller (SP3700)
- Roof Unit:** Passive Heat MCU (SP3703)
- Control Cable:** 5-Pin Pre-terminated (SP5232)
- Modes of Operation:**

Zone Keypad



Zone Keypad Rear View



The same controller is used for anything between 1 & 6 Zones

Note Dip Switches and Jumper in right top corner

## SYSTEM INSTALLATION - KEYPAD

1. On the keypad circuit board are two cable headers, the eight core cable from the Zone Controller is fitted to the eight pin header (Primary Keypad). Where an optional extra keypad (Secondary/Slave Keypad) is installed the seven core cable links the two keypads.
2. On the rear of the keypad circuit board are 8 Dip switches. On The Primary keypad these need to be set. Dip switches 1 – 6 control the 6 zones. For a 3 zone system Dip switch 1,2 and 3 need to be in the ON position. The dip switch setting for 7 and 8 will depend on the defaults required by the system.  
Dip 7 On and Dip 8 Off = Zone 1 defaults to open. Dip 7 On and Dip 8 On = Zone 1 and 2 default to open.
3. When a Secondary/Slave keypad is fitted the dip switches, on the rear, do not need to be set. The Primary keypad settings control the dampers.

## Secondary/Slave Keypad

Primary/Master Keypad - J1 Jumper - OFF  
Secondary/Slave keypad - J1 Jumper - ON